

VT.3[®] WATER BOILER

INSTALLATION & MAINTENANCE MANUAL

Models (400, 500, 650, 750, 850, 900 and 1000) WB 125A-IF

Installation and service must be performed by a qualified service installer, service agency or the gas supplier.

IMPORTANT: THIS MANUAL CONTAINS INFORMATION REQUIRED FOR INSTALLATION, OPERATION AND MAINTENANCE OF THIS EQUIPMENT. READ AND FOLLOW THE INFORMATION IN THIS MANUAL AND ALL OTHER PROVIDED INSTRUCTIONS, LABELS AND MARKINGS BEFORE INSTALLING, OPERATING OR SERVICING THIS UNIT.



TO THE INSTALLER: After installation, these instructions must be given to the equipment user or left near the appliance.
SPECIAL INSTRUCTIONS TO THE OWNER: Retain this manual for future reference. These instructions contain important information that will help you in maintaining and operating this appliance.

Riverside Hydronics®, LLC
3209 Galvez Avenue
Fort Worth, Texas 76111
1-800-990-5918
www.riversidehydronics.com

TABLE OF CONTENTS

- 1. Safety Considerations**
- 2. Product Description**
- 3. Boiler Installation**
 - 3.1. Checking Equipment Before You Install
 - 3.2. Codes
 - 3.3. Electrical Requirements
 - 3.4. Location
 - 3.5. Service Clearances
 - 3.6. Clearances to Combustible Surfaces
- 4. General Piping Guidelines**
 - 4.1. Inlet and Outlet Connections
 - 4.2. Supply and Return Piping
 - 4.3. Temperature Control Sensor (Install in system return piping)
 - 4.4. Filling the Boiler
- 5. Gas Supply Piping**
 - 5.1. Inlet Gas Pressure
 - 5.2. Manifold Gas Pressure
 - 5.3. Gas piping Size
 - 5.4. Appliance Isolation during Gas Supply Piping Pressure Test
 - 5.5. Gas Connection
 - 5.6. Gas Train and Controls Certification
 - 5.7. Gas Control Trains
- 6. Combustion and Ventilation Air**
 - 6.1. Equipment Located In Confined Spaces
 - 6.2. Maximum Allowed Remote Combustion Air Inlet Length (Equivalent Length)
 - 6.3. Remote Combustion Air Cap
 - 6.4. Vertical or Horizontal Remote Air Duct Termination
 - 6.5. Remote Air Consideration for Combined Remote Air Ducting
- 7. Venting**
 - 7.1. Venting the Unit Category I, III or IV Venting Materials
 - 7.2. Category I Venting
 - 7.3. Category III or IV Venting
 - 7.3.1 Maximum Category III or Category IV Vent Length
 - 7.3.2 Vertical or Horizontal Vent Termination
 - 7.3.3 Combining Category III or Category IV Vents
- 8. Operating and Safety Controls**
 - 8.1. Operating Temperature Control
 - 8.2. High Water Temperature Limit Control
 - 8.3. Relief Valve
 - 8.4. Electronic Low Water Cut-Off

- 9. TempTrac Controller Panel**
 - 9.1. Principle of Operation
 - 9.2. Upper LED Readout
 - 9.3. Lower LED Readout
 - 9.4. Control Buttons
 - 9.5. Modulation Firing Sequence
 - 9.6. To View the Setpoint
 - 9.7. To Change The Setpoint
 - 9.8. To Change Other Parameters
 - 9.9. LED Display Alarm Messages
- 10. Boiler Control Interface**
 - 10.1. If BMS is to provide remote on/off control only
 - 10.2. If BMS provides Modulation control through a 4 to 20 milliamp
 - 10.3. Modbus Application for TempTrac
 - 10.4. Boiler Management System (BMS) Remote Connections
 - 10.5. Outdoor Reset
 - 10.6. OnTrac Boiler Management System (BMS)
 - 10.7. BAS Protocol Gateway
- 11. Sequence of Operation**
- 12. Initial Startup**
 - 12.1. Initial Startup Requirements
 - 12.2. Tools and Instrumentation Required
 - 12.3. Resources
 - 12.4. On-Site Considerations
 - 12.5. Startup Procedure
- 13. Troubleshooting Guide**
- 14. Replacement Parts**
 - 14.1. Control Panel
 - 14.2. Control Panel Components Parts List
 - 14.3. Burner Assembly and Gas Train Exploded View
 - 14.4. Burner Assembly and Gas Train Parts List
- 15. Periodic Maintenance**
- 16. Recommended Maintenance Schedule**

Warranty Forms & Wiring Diagrams Ship Separately With Each Product

1 SAFETY CONSIDERATIONS

WARNING: If the information in the supplied manual(s) is not followed exactly, a fire, explosion or exposure to hazardous materials may result, causing property damage, personal injury or death.

FOR YOUR SAFETY

- Do not store or use gasoline or other flammable vapors or liquids in the vicinity of this or any other appliance.

WHAT TO DO IF YOU SMELL GAS

- Do not try to light any appliance.
- Do not touch any electric switch; do not use any phone in your building.
- Immediately call your gas supplier from a location away from your building and the smell of gas. Follow the gas supplier's instructions.
- If you cannot reach your gas supplier, call the fire department.

Installation and service must be performed by a qualified installer, service agency or the gas supplier.

This product contains, or may come to contain materials that have been identified as carcinogenic, or possibly carcinogenic to humans. Before installing, servicing or removing this product, read and follow the supplied instructions

WARNING: Installation and service must be performed by a qualified installer, service agency or the gas supplier, who must read and follow the supplied instructions before installing, servicing or removing this appliance. Refer to the information contained in this manual. Improper installation, adjustment, alteration, service or maintenance can cause property damage, personal injury, exposure to hazardous materials or death.

WARNING: Do not use this appliance if any part has been under water. Immediately call a qualified service technician to inspect the unit and to replace any part of the control system, all gas controls and all other items affecting safe appliance operation and which has been under water.

WARNING: In an emergency shut the main gas supply valve to the appliance from a location safely away from the emergency. Failure to follow these instructions can cause property damage, personal injury, and exposure to hazardous materials or death.

PRODUCT SAFETY INFORMATION REFRACTORY CERAMIC FIBER PRODUCT WITH CRYSTALLINE SILICA

WARNING: This product contains or may come to contain crystalline silica, which has been identified by the International Agency for Research on Cancer (IARC) as carcinogenic to humans. This product also contains refractory ceramic fibers, which have been identified by the IARC as possibly carcinogenic to humans. Avoid breathing fiber particulates and dust.

RISKS:

- Air borne fibrous insulation is a possible cancer hazard by inhalation.
- Airborne crystalline silica may cause silicosis (lung disease) by inhalation.
- May cause temporary irritation to eyes, skin, and respiratory tract.

PRECAUTIONARY MEASURES:

- Minimize airborne fibers with engineering controls.
- Use NIOSH/MSHA approved respirators as required (see MSDS).
- Wear long sleeved, loose-fitting clothing, eye protection and gloves.

FIRST AID MEASURES: (If any of the irritations listed persists, seek medical attention)

- Eyes: Flush with water.
- Skin: Wash with soap and warm water.
- Ingestion: Do not induce vomiting. Get medical attention if gastrointestinal symptoms develop.
- Inhalation: Remove to fresh clean air.

WARNING: If you are unfamiliar with the safe handling of refractory ceramic fiber products, or if you wish additional information prior to beginning any disassembly of the water heater or boiler that might expose refractory ceramic fiber materials, contact: Unifrax Corporation, 2351 Whirlpool Street, Niagara Falls, NY 14305-2413, 1-800-322-2293.

IDENTIFICATION OF REFRACTORY CERAMIC FIBER MATERIALS (RCF):

The burner, lower tank and upper and lower flue collector assemblies utilize RCF material. (The RCF materials are located within the product and not generally exposed except during service, disassembly or assembly.)

**2 PRODUCT DESCRIPTION Component, Controls and Connection Locations
(Locations May Vary)**

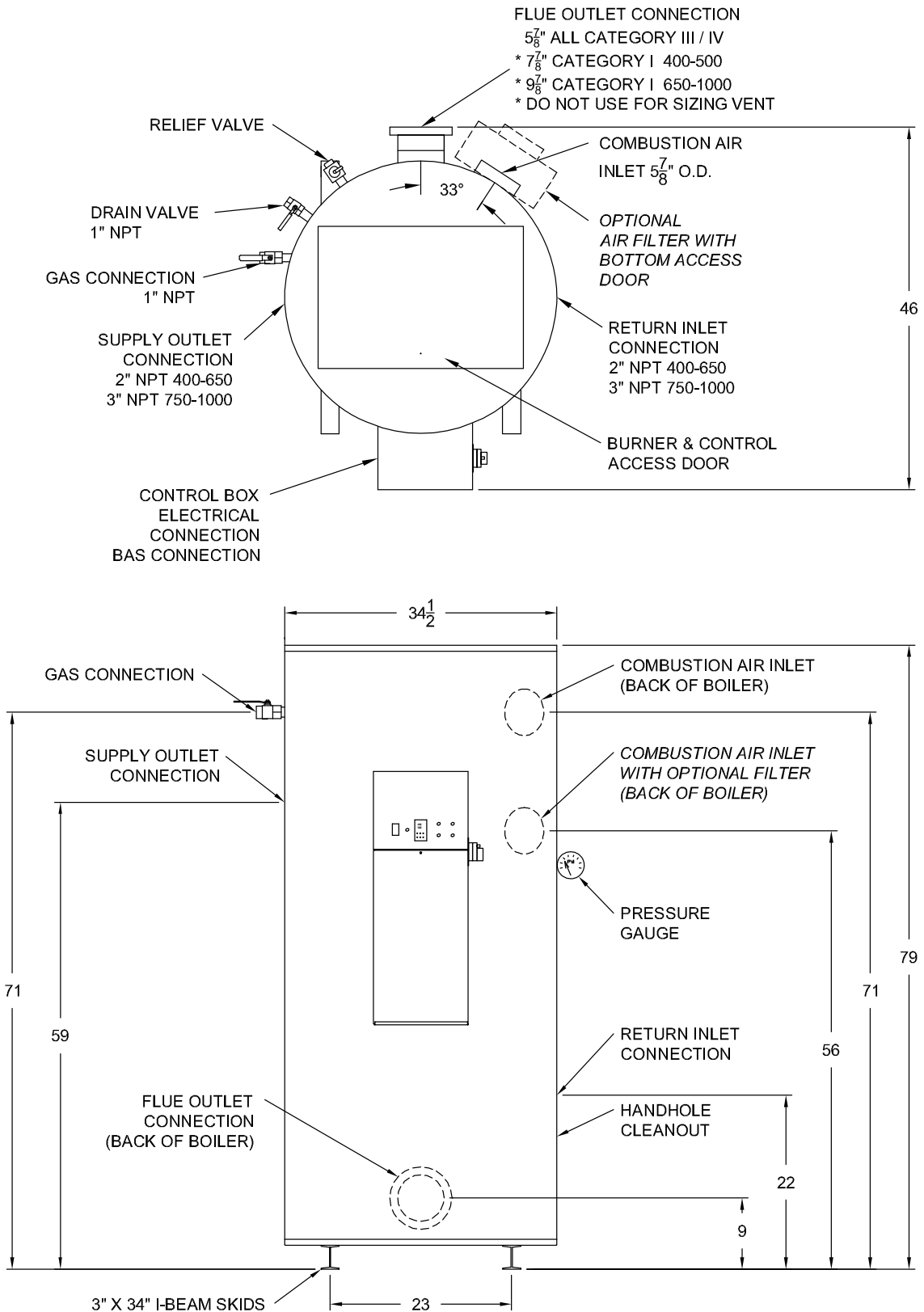

3 BOILER INSTALLATION

3.1 Checking Equipment Before You Install

Inspect the unit completely upon receipt from the freight carrier before signing the bill of lading. Inspect the appliance and all accompanying parts for signs of impact or mishandling. Verify the total number of pieces shown on packing slips with those actually received. Contact the freight carrier immediately if any damage or shortage is detected.

3.2 Codes

The equipment must be installed in accordance with those installation regulations in force in the local area where the installation is to be made. Authorities having jurisdiction must be consulted before installation is made. In the absence of such requirements, the installation must conform to the latest edition of the National Fuel Gas Code, ANSI Z223.1. Where required by the authority having jurisdiction, the installation must conform to American Society of Mechanical Engineers Safety Code for Controls and Safety Devices for Automatically Fired Boilers, No. (CSD-1). Where required by the Canadian authority having jurisdiction, the equipment must be installed in accordance with the latest edition of the Installation Code for Gas Burner Appliances and Equipment CAN/CSA B149 and/or B149.2 and applicable Provincial Regulations. All appliances conform to the latest edition of the ASME Boiler and Pressure Vessel Code, Section IV.

3.3 Electrical Requirements

See appliance rating decal for electrical service requirements. The appliance must be electrically supplied and grounded in accordance with the requirements of the authority having jurisdiction or in the absence of such requirements, with the latest edition of the National Electrical Code ANSI/NFPA No. 70. When the unit is installed in Canada, it must conform to the CSA C22.1, Canadian Electrical Code, Part 1 and/or Local Electrical Codes.

- All wiring between the unit and field installed devices must be made with type T copper wire.
- Line voltage wire exterior to the appliance must be enclosed in approved conduit or approved metal clad cable.
- To avoid serious damage, **DO NOT** energize the unit until the system and appliance is full of water.

3.4 Location

These units are suitable for indoor installation only.

- The boiler may be installed on a 4 inch to 6 inch housekeeping pad.
- Locate the unit so that if water connections should leak, water damage will not occur. When such locations are unavoidable, install a suitable drain pan, and plumb pan to ensure adequate drainage in the event of a leak. Under no circumstances is the manufacturer responsible for water damage in connection with this unit, or any of its components. The manufacturer's warranty does not cover water damage.
- Protect associated electrical components and electrical connections from water (dripping, spraying, rain, etc.) during appliance operation and service.
- Place the appliance on a level, non-combustible floor. Concrete over wood is not considered non-combustible.
- Do not install on carpet or other combustible floor coverings. If installation over a combustible floor is required, follow these guidelines:
 - Use a base of hollow clay tile or concrete blocks from 8" to 12" thick and extending 24" beyond the sides.
 - Place the blocks in line so that the holes line up horizontally to provide a clear passage through the blocks.
 - Install 1/2" fireproof millboard with a 20-gage sheet metal cover over the block base.
 - Center the unit on the base. Also follow this procedure if electrical conduit runs through the floor, and beneath the appliance. A field-installed base must meet all local fire and safety code requirements.

3.5 Service Clearances

Provide adequate clearances on all sides for installing and servicing connections such as water, gas, vent, combustion air duct, electrical, pump and other auxiliary equipment. At least 24" above the boiler is required for filter replacement and burner/gas control service.

3.6 Clearances To Combustible Surfaces

Minimum 1" clearance must be provided from any vent surface to adjacent combustible material. The minimum clearances to unprotected combustible material are 24" be provided at the front, 8" be provided at the rear and 8" at top, left and right sides of the appliance.

4 GENERAL PIPING GUIDELINES

Consult factory for piping of hybrid boiler systems that contain both condensing and non-condensing boilers.

4.1 Inlet and Outlet Connections

The connection to the unit marked "Inlet" on the header connects to the return from the system (water to be heated). The connection on the header marked "Outlet" connects to the supply side of the system (hot water out of the unit).

4.2 Supply and Return Piping (For Non-hybrid Boiler System)

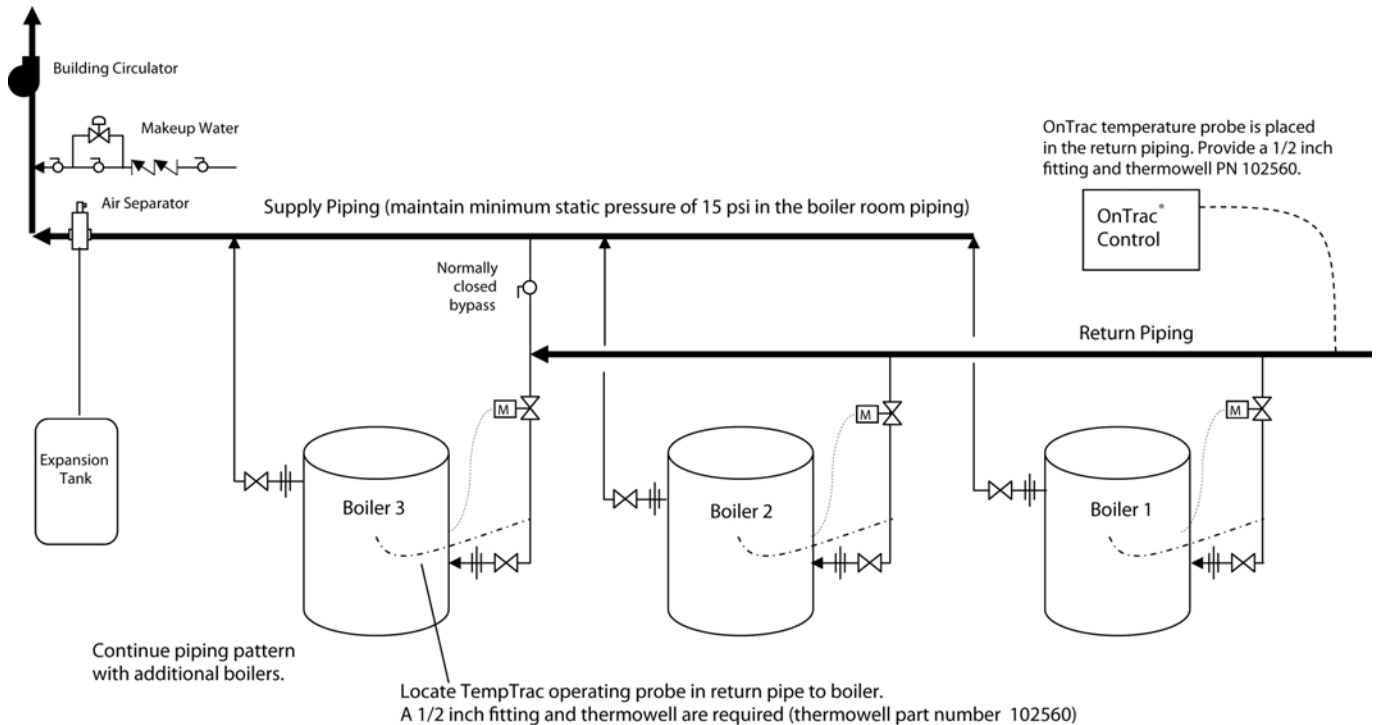

NOTE: For motorized isolation valves on each boiler's inlet piping:

- In constant flow building loops, motorized isolation valves must NOT be used.
- In buildings with variable flow pumping systems on the boiler loop, motorized isolation valves may be recommended. Building flow may have to be limited to only the firing boilers during periods of low building heat demand to prevent temperature from reaching the boiler's operating limit.
- It is recommended that the OnTrac multiple boiler control be used to control these valves. Consult your Riverside Hydronics representative for design assistance.

4.3 Temperature Control Sensor

The Temperature Control Sensor is coiled and secured to the control enclosure along with the Sensor Thermal Well.

IMPORTANT: The thermal well must be installed in the return plumbing 1 to 4 feet from the return connection on the boiler. The sensor should then be inserted into the thermal well along with thermal conductive paste. Use the plastic threaded plug to secure the sensor in place.

TEMPERATURE CONTROL
SENSOR AND THERMAL WELL

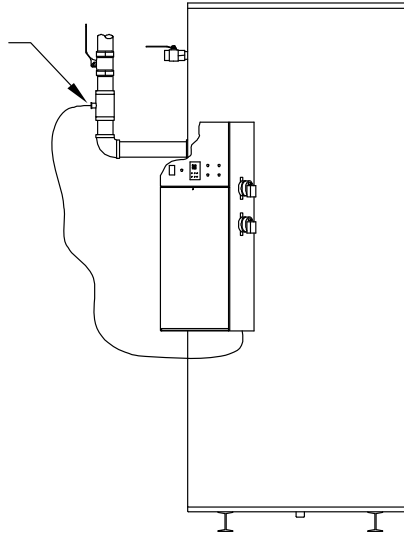

4.4 Filling The Boiler

- 1 Fill the system with water. To be sure that the unit is not “air bound,” open the relief valve. Leave the valve open until a steady flow of water is observed. Close valve and complete filling the system.
- 2 In hard water areas, water treatment should be used to reduce introduction of minerals into the system. Excessive buildup of minerals in the heat exchanger can cause a non-warrantable failure.
- 3 Make sure there are no system leaks. DO NOT use petroleum based stop-leak products. All system leaks must be repaired. The constant addition of make-up water to a closed loop boiler system can cause minerals to collect in the heat exchanger. Excessive buildup of minerals in the heat exchanger can cause a non-warrantable failure.
- 4 For systems requiring freeze protection, use only hydronic system antifreeze with a maximum concentration of 50%. Follow the glycol manufacturer’s instructions. DO NOT use undiluted or automotive type antifreeze.

5 GAS SUPPLY AND PIPING

Verify that the type of gas specified on rating plate is supplied to the unit. This unit is orificed for operation up to 2000 feet altitude. Appliance btuh output derates 4% per 1000 feet elevation above sea level. Consult Factory for installations above 2000 feet elevation.

- 5.1 Inlet Pressure:** Measured at the inlet pressure tap located at the main gas cock. The inlet pressure must remain within the minimum and maximum values while the unit is at rest and while the unit is operating at maximum firing rate.

INLET PRESSURE	NAT. GAS	LP
Maximum Static Pressure (Inches-Water Column)	14"	13"
Minimum Flow Pressure (Inches-Water Column)	4.5"	11"

- 5.2 Manifold Pressure:** Measure at the pressure tap on the downstream side of the manual shutoff valve closest to the burner. The rated manifold pressure appears on the product data label located on the front of the appliance.

- 5.3 Gas Piping Size:** Use the values in "Convert Fittings To Equivalent Straight Pipe" to add the equivalent straight pipe for each elbow or tee to obtain the total distance from the meter. Use this corrected total distance from the meter for determining the suggested pipe size in the "Single Unit Installation Suggested Gas Pipe Size" table.

CONVERT FITTINGS TO EQUIVALENT STRAIGHT PIPE								
Diameter Fitting (inches)	¾"	1"	1¼"	1½"	2"	3"	4"	5"
Equivalent Length of Straight Pipe (feet)	2'	2'	3'	4'	5'	10'	14'	20'

Equivalent Feet From Meter	SINGLE UNIT INSTALLATION SUGGESTED PIPE SIZE					
	Maximum Capacity for Natural Gas* MBTU/HR Based on 0.5" W.C. Pressure Drop**					
	1-1/4"	1-1/2"	2"	2½"	3"	4"
25	860	1320	2475	3900	7000	-
40	660	990	1900	3000	5300	-
60	-	810	1520	2400	4300	-
80	-	690	1300	2050	3700	-
100	-	620	1150	1850	3250	6700
125	-	-	1020	1650	2950	6000
150	-	-	950	1500	2650	5500
175	-	-	850	1370	2450	5000
200	-	-	800	1280	2280	4600

*Multiplier for Propane: 1.57

**Multiplier for alternate pressure drops: 0.3" W.C. 0.77; 1.0" W.C. 1.41; 2.0" W.C. 2.00; and 4.0" W.C. 2.82.

MULTIPLE UNIT INSTALLATIONS GAS PIPING SIZE CHART

Maximum Capacity of Pipe in Thousands of BTU's per hour for gas pressures of 14 Inches Water Column (0.5 PSIG) or less and a pressure drop of 0.05 Inch Water Column (Based on NAT GAS, 1025BTU's per Cubic Foot of Gas and 0.60 Specific Gravity).

Nominal Iron Pipe Size, Inches	Length of Pipe in Straight Feet													
	10	20	30	40	50	60	70	80	90	100	125	150	175	200
3/4	369	256	205	174	155	141	128	121	113	106	95	86	79	74
1	697	477	384	328	292	267	246	256	210	200	179	164	49	138
1 1/4	1400	974	789	677	595	543	502	472	441	410	369	333	308	287
1 1/2	2150	1500	1210	1020	923	830	769	707	666	636	564	513	472	441
2	4100	2820	2260	1950	1720	1560	1440	1330	1250	1180	1100	974	871	820
2 1/2	6460	4460	3610	3100	2720	2460	2310	2100	2000	1900	1700	1540	1400	1300
3	11200	7900	6400	5400	4870	4410	4000	3800	3540	3300	3000	2720	2500	2340
4	23500	16100	13100	11100	10000	9000	8300	7690	7380	6870	6150	5640	5130	4720

5.4 Appliance Isolation during Gas Supply Piping Pressure Test

1. The appliance and its individual shutoff valve must be disconnected from the gas supply piping system during any pressure testing of that system at test pressures in excess of ½ PSI (3.5 kPa).
2. The appliance must be isolated from the gas supply piping system by closing its individual manual shutoff valve during any pressure testing of the gas supply piping system at test pressures equal to or less than ½ PSI (3.5 kPa).
3. The appliance and its gas connection must be leak-tested before placing it in operation.

5.5 Gas Connection

1. Safe operation of unit requires adequate gas supply with the required static and dynamic (flow) pressures. Actual piping selection depends on many variables that must be carefully considered by the gas piping system designer. Do not select gas pipe sizes based only on the supplied tables. These tables are for use by the gas piping system designer as a reference in checking pipe size selections.
2. Gas pipe size may be larger than boiler connection.
3. Installation of a union is suggested for ease of service.
4. Install a manual main gas shutoff valve, outside of the appliance gas connection and before the appliance gas valve, as required by the National Fuel Gas Code.
5. The gas system installer should clearly identify the emergency shut-off device.
6. A sediment trap (drip leg) MUST be provided in the inlet of the gas connection to the unit.
7. The code compliant vent limiters are designed and must respond to pressure changes in the installation environment, as opposed to outdoor ventilation. For proper operation, do not connect to outdoor atmosphere.

5.6 Gas Train and Controls Certification

NOTE: The gas train and controls assembly provided on this unit have been tested under the applicable Nationally Recognized Standard to comply with minimum safety and performance criteria such as proper ignition, combustion and safety shutdown operation.

5.7 Gas Control Trains

All models include gas control trains with the following components: main gas cock, a dual safety valve, proportionator regulator and a final manual shutoff valve with the manifold pressure tap on the side of the valve.

CAUTION: Do not adjust or remove any screws or bolts on gas train control components which are sealed with a red or blue colored compound. Doing so will void all approvals and warranties.

6 COMBUSTION AND VENTILATION AIR

Provisions for adequate combustion and ventilation air to the mechanical room must be in accordance with Section 5.3, Air for Combustion and Ventilation of the latest edition of the National Fuel Gas Code, ANSI Z223.1 and/or CAN/CSA B149, Installation Codes or applicable provisions of the local building codes.

6.1 Equipment Located In Confined Spaces

Equipment located in confined spaces requires two openings installed within 12" (30.5 cm) from the top and bottom of the room to assure adequate combustion air and proper ventilation. The total input of all gas utilization equipment installed in the room must be used to determine the required minimum air volume needed for combustion, ventilation and dilution of flue gasses.

- **All Air From Outdoors:**
Each opening requires a minimum free area of 1 square inch per 4000 Btu/hr input if directly communicating with the outdoors or communicating to the outdoors through vertical ducts.
Each opening requires a minimum free area of 1 square inch per 2000 Btu/hr input if communicating with the outdoors through horizontal ducts.
- **All Air From Inside The Building:**
Each opening requires a minimum free area of 1 square inch per 1000 Btu/hr input, but not less than 100 square inches (0.06 m²).
- **Combination Of Air From The Indoors And From The Outdoors:**
Refer to National Fuel Gas Code, ANSI Z223.1 and/or CAN/CSA B149, Installation Codes or applicable provisions of the local building codes.

NOTE: This unit may be installed with a remote air intake system which uses a make-up air duct to draw combustion air directly from outdoors. (See Vertical and Horizontal Remote Air.)

WARNING – Adequate clean combustion air must be provided to the appliance. Under no circumstances should the appliance ever be under a negative pressure. Particular care should be taken when exhaust fans, compressors, air handling units, etc. may rob air from the appliance. The combustion air supply must be completely free of any chemical or fumes, which may be corrosive to the appliance. Some common chemical fumes to avoid are fluorocarbons and other halogenated compounds, most commonly present as refrigerants or solvents, such as Freon, trichloroethylene, perchlorethylene, chlorine, etc. These chemicals, when in contact with the equipment or when burned, form acids which quickly attack the tubes, flue collector, stack and other appliance and auxiliary equipment. The result of inadequate clean combustion air or negative pressure can be premature unwarranted product failure or unsafe operation producing carbon monoxide that could escape into the building. Exposure to carbon monoxide can lead to personal injury or death.

6.2 Maximum Allowed Remote Combustion Air Inlet Length (Equivalent Length)

A vertical or horizontal remote air inlet system can be connected to this appliance without modification. The maximum length of field supplied single wall pipe, such as galvanized ventilation pipe, is shown in the chart below titled Maximum Air Inlet Duct Equivalent Length. Use metal tape or RTV sealant to seal each pipe joint.

Maximum Air Inlet Duct Equivalent Length				
Duct Size	6" Duct	7" Duct	8" Duct	9" Duct
Max Equivalent Length	100 feet	130 feet	250 feet	450 feet

To determine the maximum straight length of duct allowed, use the Duct Fitting Equivalent Length chart below to find the total equivalent length for all duct fittings in your combustion air system. Then subtract this number of feet from

the total equivalent length allowed in Maximum Air Inlet Duct Equivalent Length chart above. The sum of this calculation is the maximum length of straight duct allowed. If a longer length is required, repeat the calculation using a larger duct size. No additional deduction is required for the addition of the duct system terminal.

Duct Fitting Equivalent Length				
Duct Pipe:	6" Duct	7" Duct	8" Duct	9" Duct
90° Elbow	8 feet	9 feet	10 feet	11 feet
90° Long Radius Elbow	5 feet	5 feet	5 feet	6 feet
45° Elbow	5 feet	5 feet	5 feet	5 feet

The following remote air duct information is provided for use in design calculations, if needed.

Air Duct Specifications	
Boiler Input Mbtu	Required Air (SCFM)
399	87
500	108
650	141
750	163
850	184
900	195
1000	217

6.3 Remote Combustion Air Cap

A UL Listed air intake vent termination cap **MUST** be attached to the remote combustion air vent termination to adequately protect the combustion air inlet from wind and weather. A UL Listed air intake termination cap is available from Riverside Hydronics and may have shipped with the boiler as a purchased option.

6.4 Vertical or Horizontal Remote Air Duct Termination

- Air inlet and exhaust vents should terminate in the same wind pressure area whenever possible.
- Air inlet must be located no less than 3 feet (0.91m) below the exhaust terminal if they are within 10 feet (3.05 m) of each other.
- If terminating through the roof, the air inlet must terminate at least 12 inches (0.3 m) above roof level and at least 12 inches (0.3 m) above snow levels.
- If terminating through a sidewall, the air inlet must terminate at least 12 inches (0.3 m) above grade and/or at least 12 inches (0.3 m) above normal snow levels.

Vertical Remote Air (recommended)

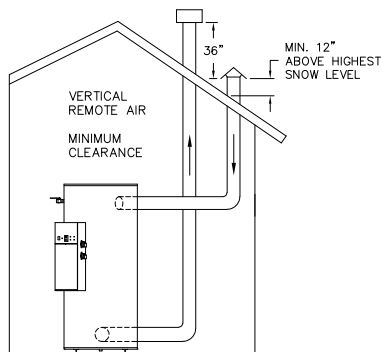

Horizontal Remote Air (allowed)

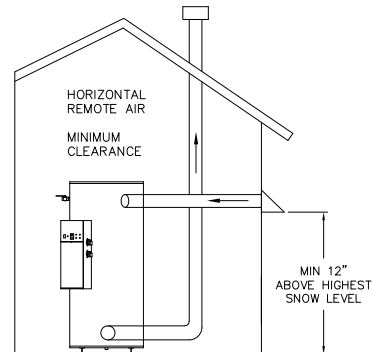

6.5 Remote Air Consideration for Combined Remote Air Ducting

Each boiler **MUST** have separate intake piping. Consult factory for common air intake assistance.

7 VENTING

7.1 Venting the unit using Category I, III or IV Venting Materials

The following instructions can be used to install the VT3 using UL, ULC, ETL or CSA listed, Category I, negative pressure, non-condensing vent materials, like type B venting or it can be installed using smaller diameter UL, ULC, ETL or CSA listed, stainless steel, Category III, positive pressure, non-condensing venting materials. UL, ULC, ETL or CSA listed, stainless steel, Category IV, positive pressure, condensing ready venting materials can also be used to substitute for the Category III venting materials.

Look at the main information decal attached near the front of the unit to determine whether the appliance is for installation utilizing Category I venting only, Category III venting only or if the appliance is for installation utilizing Category I, III or IV venting. Follow the instructions below for the specific Category of venting selected and that appears on the main information decal. Once the Category is selected, follow only the instructions given for that Category.

WARNING: Venting instructions for Category I (negative vent pressure) and Category III/IV (positive vent pressure) must not be mixed. Mixing or following instructions for a different Category can cause inadequate venting or allow carbon monoxide to enter an occupied space, resulting in property damage, personal injury or death.

7.2 CATEGORY I VENTING

When properly installed with UL, ULC, ETL or CSA listed Category I venting, the appliance operates with a non-positive vent static pressure and with a vent gas temperature that **avoids excessive condensate production in the vent.**

Category I venting should terminate above the roof surface and must be installed in accordance with the "Venting of Equipment" section of the current edition of the National Fuel Gas Code, ANSI Z223.1 / NFPA 54 or, in Canada, the "Venting Systems and Air Supply for Appliances" section of the current edition of the CAN/CSA B149.1-10 Installation Codes, or applicable provisions of the local building codes.

- Do not use the vent connection size to determine the necessary vent connector, vent or stack size. For proper sizing use the National Fuel Gas Code "Fan-assisted" table.
- Locate unit(s) as close as possible to the vent or stack. The vent connector from the appliance vent connection to the vertical vent or stack that terminates outside and above the building roof must be made with listed Type "B" double wall (or equivalent), must be as direct as possible and must have no blockage or reduction in diameter.
- Support horizontal portions of the venting system to prevent sagging. Horizontal runs must slope upwards not less than 1/4 inch per foot (21 mm/m) from the appliance to the vent terminal. Follow manufacturer's instructions.
- Do not attach the vent connector of any appliance vented by natural draft to any portion of a mechanical draft system operating under positive pressure.
- A barometric damper (draft control) is supplied with all models, unless the CAT34 option is ordered. If the boiler was ordered with the CAT34 option, but is going to be installed with a Category I vent system, a barometric damper and vent size increaser (for attachment of the vent connector to the boiler vent connection) sized to match the required Category I vent diameter, must be obtained from Riverside Hydronics. Attach the properly sized vent increaser to the boiler vent connection with three sheet metal screws. A properly installed and adjusted barometric damper helps stabilize draft and regulate high updraft. Conventional vented multiple unit installations with combined venting require barometric dampers to regulate draft at each unit. Adjust the barometric damper to 0.04 inches water column updraft, when used. Follow the barometric damper manufacturer's installation instructions.
- **The draft in vent should be within a range of -.02 and -.08" W.C.**
- A UL, ULC, ETL or CSA listed vent terminal, suitable for Category I products, **must** be installed to adequately protect the gas vent from wind and weather.
- The vent terminal must extend at least 3 ft (.09 m) above the highest point where it passes through the roof of a building and at least 2 ft (.06 m) higher than any portion of a building within a horizontal distance of 10 ft. (3.0 m).
- The vent cap must terminate at least 3 feet (0.91 m) above any forced air inlet within 10 feet (3.05 m); 4 feet (1.22 m) below, 4 feet (1.22 m) horizontally from or 1 foot (0.3 m) above any door, window or gravity air inlet to the building; 1 foot (0.3 m) above grade, 1 foot (0.3 m) above the highest snow levels and must terminate at least 7 feet (2.13 m) above grade when located adjacent to public walkways or gathering areas.
- The vent terminal must not be installed closer than 3 feet (0.91 m) from an inside corner of an L-shaped structure.

WARNING: Do not combine appliances utilizing Category I or Category II venting into the same vent system with appliances utilizing Category III or Category IV venting. This could cause unsafe operation and the potential for poisonous carbon monoxide to enter occupied areas. Such improper installation can cause property damage, personal injury, exposure to hazardous materials or death.

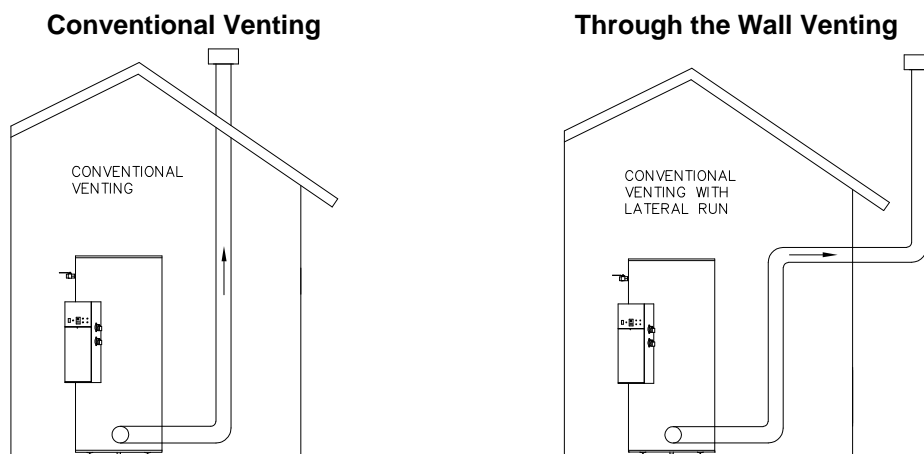

7.3 CATEGORY III or IV VENTING

When properly installed with a UL, ULC, ETL or CSA listed, stainless steel, Category III or Category IV vent, the appliance operates with a positive vent static pressure and with a vent gas temperature that **avoids excessive condensate production in the vent**. Although the appliance can be installed to operate and require Category III vent materials, Category IV vent materials can be substituted, but are not required.

The listed Category III or Category IV, stainless steel gas vent connected to this appliance may terminate either above the roof surface or through the side wall. It must comply with the latest edition of the National Fuel Gas Code, ANSI Z223.1 / NFPA 54 or, in Canada, CAN/CSA B149.1-10 Installation Codes, and the applicable provisions of the local building codes.

- **IMPORTANT:** Do not use plastic venting of any type.
- Remove the vent increaser (if equipped) from the boiler vent connection. The Category III or IV venting systems must connect directly to the 5-7/8 inch boiler vent connection and must not use the vent increaser as part of the vent system.
- Obtain the correct adapter for attaching and sealing to the VT3 5-7/8 inch vent connection outlet from the manufacturer of the listed Category III or IV venting system being installed. Attach this adapter to the VT3 vent connection outlet following the instruction provided by the adapter's manufacturer.
- Follow the Category III or Category IV vent manufacturers' instruction for installation, sealing and support of their vent system.
- For proper vent operation and to protect the gas vent from wind and weather, use **ONLY** the listed vent terminal specified by the Category III or Category IV vent system manufacturer.
- **IMPORTANT:** Do not use a barometric damper when applying Category III or Category IV venting.
- This product uses the positive pressure generated by the burner system blower to push combustion products out of the vent. The vent system must be a stainless steel and UL, ULC, ETL, or CSA certified for use with an appliance requiring a Category III or Category IV, pressurized vent system. Seal all joints and support horizontal lengths of vent and follow all installation instructions required by the vent manufacturer.

WARNING: Use only stainless steel venting listed by a nationally recognized testing laboratory for Category III or Category IV, positive pressure, gas appliance venting. Use of plastic pipe of any type or use of venting material other than specified in these instructions can result in failure of the venting system and/or exposure to carbon monoxide, which can result in property damage, personal injury or death.

WARNING: When using Category III or Category IV venting, do not connect this appliance to an existing or traditional gas vent or chimney or combine the vent with any other appliance, except as provided in Section 8.3.3 "Combining Category III or Category IV Vents." Such venting could result in failure of the venting system and/or exposure to carbon monoxide which can result in property damage, personal injury or death.

7.3.1 Maximum Category III or Category IV Vent Length (Equivalent Length)

If a vertical or horizontal Category III or Category IV vent system is used with this appliance, the maximum length of field supplied venting is shown in the chart below titled Maximum Category III – Category IV Vent Equivalent Length.

Maximum Category III – Category IV Vent Equivalent Length				
Vent Size	6" Vent	7" Vent	8" Vent	9" Vent
Max Equivalent Length	100 feet	130 feet	250 feet	450 feet

Pipe fittings reduce the maximum allowable vent length. Use the Category III or Category IV vent manufacturer's equivalent length deduction for all elbows, terminations, etc. If the information is not readily available from the vent manufacturer, use the Vent Fitting Equivalent Length chart below to find the total equivalent length for all vent fittings in your combustion air system. Then subtract this number of feet from the total equivalent length allowed in Maximum Category III – Category IV Vent Equivalent Length chart above. The sum of this calculation is the maximum length of straight vent allowed. If a longer length is required, repeat the calculation using a larger vent size. When using this chart, no additional deduction is required for the addition of the vent system terminal.

Vent Fitting Equivalent Length				
Vent Pipe:	6" Vent	7" Vent	8" Vent	9" Vent
90° Elbow	8 feet	9 feet	10 feet	11 feet
90° Long Radius Elbow	5 feet	5 feet	5 feet	6 feet
45° Elbow	5 feet	5 feet	5 feet	5 feet

The following vent information is provided for use in design calculations, if needed.

Venting Specifications		
Boiler Input MBtu/h	Combustion Air Volume (cfm)	Max Vent Press. "W.C.
399	136	0.5
500	170	0.6
650	221	0.8
750	255	1.0
850	289	1.2
900	306	1.2
1000	340	1.3

7.3.2 Vertical or Horizontal Vent Termination

1. The vent terminal must have a minimum clearance of 4 feet (1.22 m) horizontally from, and in no case be located above or below, electric meters, gas meters, regulators and relief equipment.
2. The vent cap must terminate at least 3 feet (0.91 m) above any forced air inlet within 10 feet (3.05 m).
3. The vent shall terminate at least 4 feet (1.22 m) below, 4 feet (1.22 m) horizontally from or 1 foot (0.3 m) above any door, window or building air inlet to the building.
4. The vent system shall terminate at least 1 foot (0.3 m) above grade, at least 1 foot (0.3m) above highest possible snow accumulation levels and shall terminate at least 7 feet (2.13 m) above grade when located adjacent to public walkways or gathering areas.
5. To avoid a blocked flue condition, keep the vent cap clear of snow, ice, leaves, debris, etc.
6. The vent must not exit over a public walkway, near soffit vents or crawl space vents or other areas where condensate or vapor could create a nuisance or hazard or cause property or could be detrimental to the operation of regulators, relief valves or other equipment.
7. A horizontal vent must extend one foot beyond the wall.
8. A horizontal or vertical vent terminal must not be installed closer than 3 feet (0.91m) from an inside corner of an L-shaped structure.

9. A vertical vent must exhaust outside the building at least 3 feet (0.91m) above the point of the exit and at least 2 feet (0.61 m) above the highest point of the roof within a 10-foot (3.05 m) radius of the termination.
10. A vertical termination less than 10 feet (0.91 m) from a parapet wall must be a minimum of 2 feet (0.61 m) higher than the parapet wall

7.3.3 Combining Category III or Category IV Vents

Combined VT3 Category III or Category IV gas vent systems must incorporate an Exhausto, Tjernlund or U.S. Draft variable speed, modulating, mechanical draft inducer capable of maintaining the appropriate negative draft at the end of the common flue, to assure that all boilers in the combined vent system operate with a negative draft. **Do not exceed negative 0.25" W.C.** See "Combining Vents with a Draft Inducer" illustration below.

WARNING: Do not connect multiple boiler vents into a single unpowered or fixed speed powered vent. This could cause unsafe operation and the potential for poisonous carbon monoxide to enter occupied areas. Such improper installation can cause property damage, personal injury, exposure to hazardous materials or death.

WARNING: Do not combine appliances utilizing Category I or Category II venting into the same vent system with appliances utilizing Category III or Category IV venting. This could cause unsafe operation and the potential for poisonous carbon monoxide to enter occupied areas. Such improper installation can cause property damage, personal injury, exposure to hazardous materials or death.

Conventional Venting

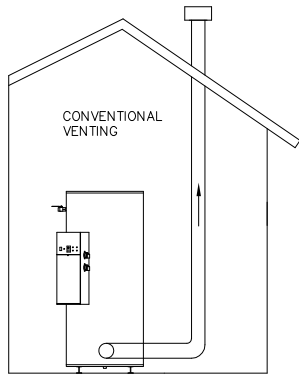

Through the Wall Venting

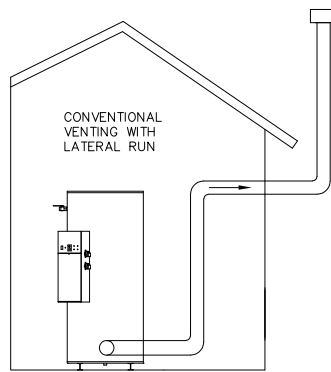

Combining Vents with a Draft Inducer

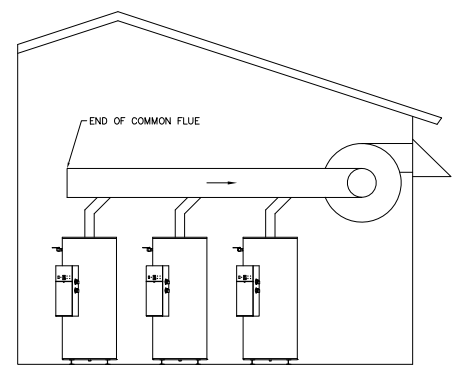

8 OPERATING AND SAFETY CONTROLS

8.1 Operating Temperature Control

An adjustable digital operating control is located in the front control panel. See TempTrac Electronic Controller Panel in this manual for more information.

8.2 High Water Temperature Limit Control

The boiler is equipped with adjustable limit and high limit controls to control the maximum discharge water temperature. These controls are located inside the control cabinet and are accessed by removing the bottom cover. The High Limit Control is of the manual reset type and may be reset by pressing the limit reset button accessible through the control panel cover. The Lower Limit is of the auto reset type and can be dial adjusted to operate just above the set point of the main Operating Temperature Control. Pressing the reset on the High Limit Control will not cause the control to reset until the water temperature has dropped below the set point of the manual reset High Limit Control.

WARNING: Turn off all electrical service to the appliance when accessing the limit or high limit controls located inside the control cabinet. This cabinet contains High Voltage wiring and terminals. If the electrical service is not turned off and these terminals are touched, a dangerous shock causing personal injury or death could occur. Close and fasten the control cabinet cover before restoring electrical service to the appliance.

8.3 Relief Valve

A pressure only relief valve(s) sized in accordance with the ASME Boiler and Pressure Vessel Code, Section IV, is installed in the tank.

CAUTION: Do not install a reducing coupling, valve or other restriction in the relief valve(s) discharge line. The discharge line shall allow complete drainage of the valve and line. Relief valves should be manually operated at least once a year.

WARNING: To prevent burns caused by hot water discharge and water damage, pipe the discharge from the relief valve to a suitable floor drain for disposal when relief occurs. Avoid contact with hot discharge water.

- **Thermal Expansion**

A relief valve that discharges periodically may be due to thermal expansion in a closed system by components, such as a backflow preventer or check valve in the cold water supply or a closed boiler heating loop. These systems must be provided with means to control expansion. Contact a boiler or plumbing professional to resolve this situation. Do not plug the relief valve.

8.4 Electronic Low Water Cut-Off

- **Low Water Cut-Off Operation**

When the water level is above the electrode position in the tank, the reset pushbutton will energize the control (LED will be lit). The control remains energized until the water level recedes below the electrode position (LED will not be lit). Unless otherwise specified, there is a three-second time delay on decreasing level. Water level must be below tank probe location for full three seconds before control de-energizes.

- **Manual Reset Operation for CSD-1 Code Compliance**

If the manual reset low water cut-off control is in a low-water condition (water off probe) and there is an interruption of power, the control will remain in the low-water condition when power is restored. To reset the low water cut-off, press the reset button when the water level is restored to a point above the probe.

9 TEMPTRAC™ ELECTRONIC CONTROLLER PANEL

9.1 Principle Of Operation

The boiler operates to satisfy the setpoint of the TempTrac digital control whose sensor is located in the return line of a Hydronic system. Demand (flow) will typically create a drop in temperature, thus activating the Centauri to add heat to the system. This setpoint is the highest temperature the appliance permits any firing to occur.



9.2 Upper Led Readout

The default display of this readout is the supply temperature sensed in the thermal well at the top of the boiler tank (Probe 2).

9.3 Lower Led Readout

The default display of this readout is the return water temperature sensed in the thermo well installed in the return water piping (Probe 1). This is used to regulate the temperature of the boiler.

9.4 Control Buttons

SET	Displays and modifies the temperature set points. In programming mode, it selects a parameter or confirms an operation.
UP	Displays and modifies the energy saving (Night Time setback) settings. In programming mode, it browses the parameter codes or increases a displayed value.
DOWN	Displays the working hours of the load relays. In programming mode, it browses the parameter codes or decreases a displayed value.
CLOCK	Changes lower display from inlet temperature to current time and day.
EXT	Changes upper display from supply temperature to outdoor reset temperature probe (when installed). Also displays the temperature difference of the return temperature minus supply temperature. In programming mode it sets the 4-20mA output (password is required).
ON/OFF	Switches the control ON or OFF.

(See TempTrac User Manual 34-80 for full description)

9.5 Modulating Firing Sequence

The boiler is fully modulating and initiates combustion at the lowest firing rate. It will modulate between this lowest possible rate and full rate as the boiler loop temperature rises and falls in relation to the operating set point. The **Parameters** involved with the modulation control sequence are **St1**, **Hy1**, **St4**, and **SR**.

LABEL	DEFAULT VALUE	NET TEMPERATURE	NET TEMP DETERMINED BY
St1	165	165°F	LED display value
Hy1	-8	157°F	St1 + Hy1
St4	-10	155°F	St1 + St4
SR	-10	145°F	St1 = St4 + SR

- **St1:** The system's desired maximum setpoint (when all firing ceases). This is the temperature setpoint of the appliance. **The factory setpoint is 165°F.**
- **Hy1:** The differential from **St1**. This is the Burner-On threshold. The burner Call-For-Heat is initiated and establishes the firing rate at low fire. **The factory default is -8°F** and is adjustable to **-1°F**.

This is the drop in temperature °F below the setpoint that the boiler must drop for the heat load to re-establish following a heat cycle (heat cycle; heat load is established, unit comes on, heat load is satisfied, unit goes off). Boiler will hold at low fire until parameter St4 is reached; causing burner to modulate higher or parameter St1 is reached; causing the burner to shutoff.

- **St4:** The Modulation Threshold. This additional differential from the St1 setting is the value when the change from low fire to modulation occurs. **The factory default setting is -10 °F and is field adjustable.**
- **SR:** The Modulation Band. This parameter is added to the St4 setting and establishes the lower end temperature of the modulation range where the burner will be operating at 100% of rate. The firing rate will increase or decrease proportionately between 100% and low fire depending upon the differential between this setpoint and St4. If loop temperature drops below the modulation range, boiler will hold at high fire. **The factory default setting is -10 °F and is field adjustable.**

The Following Example Is Based On The Factory Setting Of The TempTrac Control

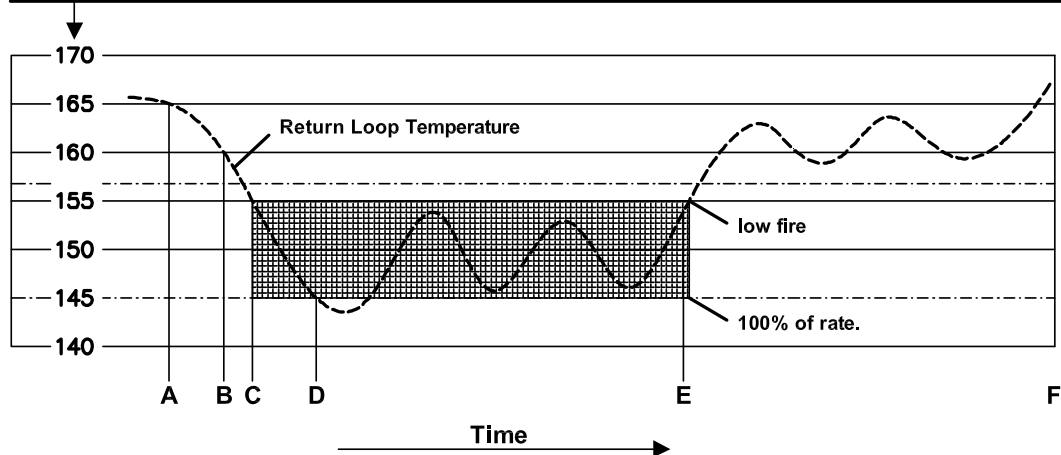

- **A to B:** A system with a setpoint of **165°F (St1)** has a heating demand placed upon it and the system temperature begins to fall. No action.
- **B:** If the sensed temperature at Probe-1 falls to **157°F (Hy1)**, the "BURNER ON THRESHOLD" is activated. This initiates the burner Call-for-Heat with a firing rate established at low fire.
- **B to C:** If further temperature fall occurs, approaching **155°F**, the firing rate remains at low fire.
- **C:** Temperature drop at **155°F (St4)** enters the "MODULATION THRESHOLD".

- **C to D:** Once modulation is established, the sensed loop temperature can fluctuate **between 155°F and 145°F (between St4 and SR)**. The firing rate increases or decreases proportionately between 100% and low fire, depending upon the temperature sensed in the return loop. Temperature rise in the heat exchanger varies accordingly, 45° to 15° depending upon the firing rate.
- **D:** The unit will remain in modulation until the sensed temperature rises above **155°F (St4)**. The firing rate returns to low fire. Modulation will only reactivate when return loop temperature drops to 155°F.
- **E to F:** Low fire is maintained if the return loop temperature ranges between **155° and 165°F**.
- **F:** This firing pattern will continue until the temperature reaches the “Burner OFF” threshold of **165°F (St1)** and shuts off.

9.6 To View The Setpoint

- Push and release the **SET** key to see the set point value.
- To return to normal display, press **SET + UP** or wait 15 seconds without pressing any key.

9.7 To Change The Setpoint

- Push the **SET** key. The upper display will show the “St1” parameter name, while the lower display will show its value.
- Use the **UP** or **DOWN** key to cycle through the parameter names.
- Push the **SET** key to modify a parameter value. The value starts flashing in the lower display.
- To change it push the **UP** or **DOWN** keys. Push the **SET** key again to confirm the value and pass to the setting of next set point.
- Repeat the operations described at points 3, 4, 5.
- **To Exit:** press **SET + UP** or wait 15 seconds without pressing any key.

NOTE: Each point has a time out of 15 seconds. If any key is pushed within 15 seconds the controller exits the set points programming procedure.

NOTE: The set value is stored even when the procedure is exited by waiting the time-out to expire.

9.8 To Change Other Parameters

- Push the **SET and DOWN** arrow simultaneously for 3 seconds.
- Select the required parameter. The name of the parameter is on the upper display; its value is on the lower display.
- Press the **SET** key: the value of the parameter will start blinking.
- Use **UP** or **DOWN** to change the value.
- Press **SET** to store the new value and move to the following parameter.
- **To Exit:** Press **SET + UP** or wait 15s without pressing a key.

9.9 LED Display Alarm Messages

Alarm messages are displayed in the upper LED readout and alternate with the default display. An alarm LED ICON is also illuminated. (See TempTrac User Manual 34-80 for full description.)

ALARM MESSAGE	CAUSE	RESULTS OF ALARM CONDITION	RECOMMENDED ACTION
"P1"	TP1 probe failure	Inlet temperature sensor is not connected or is reading incorrectly. Call for heat and burner modulation output signal will revert to low fire.	Check wiring and sensor Terminals 14 & 17
"P2"	TP2 probe failure	Temperature sensor is not connected or is reading correctly. Freeze protection is disabled.	Check wiring and sensor Terminals 15 & 17
"P3"	TP3 probe failure	Temperature sensor is not connected or is reading correctly. Outdoor reset disabled. Warm weather shutdown disabled.	Check wiring and sensor Terminals 16 & 17
"HA"	High temperature limit setpoint exceeded	Buzzer sounds, operation continues	Manual reset required
"LA"	Low temperature alarm	Buzzer sounds, operation continues	
HP	High gas pressure alarm	Unit deenergized after timer delay	Manually reset required
LP	Low gas pressure alarm	Unit deenergized after timer delay	Manually reset required
Mn1	Maintenance alarm for output 1	Buzzer sounds, operation continues	Check wiring and sensor
Mn2	Maintenance alarm for output 2	Buzzer sounds, operation continues	Check wiring and sensor
Mn3	Maintenance alarm for output 3	Buzzer sounds, operation continues	Check wiring and sensor
"rtc"	The real time clock has lost its setting	Energy saving function disabled	Reprogram clock
"rtF"	Real time clock failure	Energy saving function disabled	Replace control

10 BOILER CONTROL INTERFACE

A terminal strip for the remote connection is located behind the hinged control panel at the top of the cabinet and is accessed by removing the bottom cover and then removing the screws at the top of the hinged cover.

10.1 If BMS/BAS provides remote on/off control directly to each boiler but allows boiler to control modulation on its own:

- Remove the jumper connecting terminals R1 and R2.
- Connect the BMS output leads for the enable/disable function to terminals R1 and R2.
- Leave all other wires in their initial positions.

10.2 If BMS/BAS provides **MODULATION** control through a 4 to 20 milliamp directly to each boiler:

- Remove the jumper connecting terminals R1 and R2.
- Connect the BMS output leads for the enable/disable function to terminals R1 and R2 (no polarity).
- Remove blue wire from terminal T1 and cap the end with a wire nut. Secure the loose wire.
- Connect the BMS variable signal output leads to terminals T1 and T2 (T1 is positive, T2 is negative).
- On the TempTrac Control, move parameter St1 up to its maximum setting of 230°F. This setting effectively takes the TempTrac out of the way and allows complete control by the BMS system.

10.3 BAS connection over network with MODBUS RTU protocol (requires option ALMMB)

- An optional serial connection cable (part no. 106624) enables the TempTrac to communicate via Modbus RTU to a Building Automation System or to the OnTrac multiple boiler control. Connections are made using shielded, twisted pair wiring in a daisy chain arrangement.

10.4 Making BMS/BAS remote connections for analog and binary (on/off) signals

A terminal strip for the remote connection is located behind the hinged control panel at the top of the cabinet and is accessed by removing the bottom cover and then removing the screws at the top of the hinged cover.

IMPORTANT: Do not use single strand bell wire for remote field connections to terminals R1-R2 and C1-C2. Use only multi-strand copper wire. See table below for wire length and gauge:

Wire Gauge	18 GA	16GA	14 GA	12 GA
Maximum Length	30 FT	50 FT	75 FT	100 FT

WARNING: Turn off all electrical service to the appliance when accessing the remote connections located inside the control cabinet. These terminals are High Voltage. If the electrical service is not turned off and these terminals are touched, a dangerous shock causing personal injury or death could occur. Close and fasten the control cabinet cover before restoring electrical service to the appliance

The Following Describes The Functions Of Each Of These Terminals And The Factory-Installed Options Required To Activate The Terminals:

Note: Terminals **A1-A2** and **P1-P2** are functional only when the boiler is equipped with the factory installed options required to activate the terminals. Terminals **R1-R2**, **C1-C2** and **T1-T2** are standard pre-wired functions on all models.

R1-R2: Used to activate /de-activate boiler from remote master control.

Terminals are wired to a relay in a remote Boiler Management or Energy Management System. When relay closes, circuit from R1 to R2 is completed and appliance controls are enabled. Appliance ships from factory with jumper between terminals Remove jumper when connecting to a remote controller.

A1-A2: Used to activate a remote alarm signaling shutdown of combustion control. Provides a maximum 10 amp relay contact closure when the flame safeguard terminates combustion due to a tripped safety interlock (i.e.: air proving switch high limit switch, low water flow switch or flame sensor, etc.). **Options Required - Consult Factory.**

P1-P2: Activates remote equipment and requires confirmation signal back to the appliance. Provides a maximum 10-amp relay contact closure to activate a remote device (i.e.: mechanical room air louvers, draft inducer or power vent, etc.). The remote device must send return signal via proving switch to confirming proper operation to terminals C1-C2, prior to the appliance being able to energize. **Options Required - Consult Factory.**

C1-C2: Used for proving operation of remote device. Terminals are wired to a proving switch on a remote device such as a power venter. When relay closes, circuit from C1 to C2 is completed and appliance controls are enabled. This appliance ships from the factory with jumper between terminals.

T1-T2: Used for external modulation control. To connect external modulation control, disconnect and cap the blue wire connected to terminal T2 and connect the external modulating signal to terminals T1 (positive) and T2 (negative).

10.5 Outdoor Reset (requires option for outdoor reset through the TempTrac control, code OUTRC)

The TempTrac control is capable of an outdoor reset function independent of an external control. The option includes a third sensing probe and activates the probe in the TempTrac. The outdoor reset function overrides the St1 setting when the outdoor air temperature falls to the tt setting. St1 is increased in increments through the range established by rr2. When the outdoor air temperature falls to the bottom of the rr2 range, the St1 setting will have been adjusted upward by the amount of the rr1 value. **(See Outdoor Reset Manual #34-400.6 for full description.)**

- Factory Default Settings - The values of the Outdoor Reset and Warm Weather Shutdown functions in the TempTrac control’s parameter Pr2 menu can be changed from the factory default values listed below:

Display	Parameter Description	Value
St1	Temperature at the return boiler loop that activates /deactivates boiler firing	165° F
tt	Outdoor air temperature where outdoor reset is activated and deactivated	30° F
rr2	Outdoor air temperature range through which St1 setting will be adjusted	-20° F
rr1	Maximum increase of St1 setting when outdoor reset is activated	10° F
tt2	Outdoor air temperature where boiler is de-energized	100° F
Ht2	Differential from tt2 required to reenergize the boiler	-10° F

- Outside Air Temperature Sensor Installation - The wire leads for the outdoor sensor should be connected to the TempTrac control located on the control panel of the boiler. Use sensor P/N 102163.
- Pass the temperature sensing probe through the wall to the building's exterior. Use sound construction techniques to create and insulate the wall penetration. To operate properly, the sensor must be located away from direct sunlight and protected from the weather. The length of the wire leads on the thermister is 25 feet. If more wire is needed, it is admissible to splice 22-gage, multi-strand copper wire into the thermister coil. (Thermister probe should be protected with suitable outdoor cover.)

10.6 Riverside Hydronics® ONTRAC® Boiler Management System (BMS)

The OnTrac is a separate multiple boiler control designed to coordinate the operation of multiple boilers using TempTrac controls. This section will briefly summarize the controller’s capabilities and features. **(See ONTRAC Programming Manual #34-152 and Wiring Guide #34-151 for full description.)**

- Controls up to 20 boilers (more with expansion card).
- PID control with full-color, touch-screen interface.
- Basic functions include lead-lag outdoor reset, nighttime setback and isolation valve control.

- In hybrid systems, prioritizes and rotates through up to 12 condensing boilers before energizing and rotating through up to 8 non-condensing boilers.
- Communicates with boilers by Modbus RTU protocol over 485 serial connection (2-wire, shielded daisy chain).
- Connects to Building Automation Systems through either a 4-20mA analog signal for remote set point or over the non-proprietary Modbus TCP/IP network protocol. Gateways are available for other protocols.
- Includes two equipment activation and proving terminals for system pumps and combustion air.

10.7 BAS Protocol Gateways

When communicating over a network connection, the standard protocol of the TempTrac control is Modbus RTU. The standard protocol between the OnTrac and the BAS is Modbus TCP/IP. A gateway will be required to communicate with the BAS if it uses a different protocol. Riverside Hydronics offers pre-mapped gateways that support BACnet MSTP, BACnet IP, Lonworks or Johnson Controls N2. Consult factory for other protocols. **(For a general overview of the application of this gateway, refer to Setup Manual #34-525.)**

These third-party supplied gateways are custom-programmed components that must be sourced through Riverside Hydronics.

11 SEQUENCE OF OPERATION

1. Incoming 120VAC

- a. Full time power to the Main Control Switch
- b. Full time power to the Variable Frequency Drive

2. Power On - When the main control switch is turned on:

- a. 120v is applied to the step-down transformer (24v)
- b. 120v is applied to the L.W.C.O. terminal L1
- c. 120v is applied to the Fenwal Flame Safeguard Control
- d. 24v is applied to the TempTrac operating temperature control terminal L1

3. Call For Heat - If the TempTrac operating control senses a call-for-heat condition:

- a. The High Gas Pressure and low Gas Pressure Switch (both optional) are energized and their safe condition is proved.
- b. The thermostat contact on the Fenwal Flame Safeguard Control is energized.
- c. The flame control will then verify the Airflow-Proving Switch is in the open position, which must exist before the blower is powered.
- d. Energizing the blower should close the airflow proving switch. If the airflow-proving switch is not in the closed position, the flame control's fan terminals F1-F2 will power the Variable Frequency Drive (VFD) blower system at low speed for pre-purge.
- e. If the airflow-proving switch does not close following the blower being energized, the flame control will lockout.

4. Proof of Air Pressure Switch - The control will look for a signal from the airflow-proving switch, indicating that the blower is operating:

- a. When the airflow generated by the blower is sufficient to cause the differential air switch to close, the 15 - second pre-purge delay will start.
- b. During this period any flue products or combustible gases which may have settled in the boiler are evacuated.

5. Heat-Up - Following the pre-purge delay, the hot surface igniter will be energized:

- a. The flame control will monitor the current applied to the hot surface igniter.
- b. If the flame control determines the proving current meets the threshold, a dwell time delay starts to assure the hot surface igniter has sufficient time to reach ignition temperature.

6. Ignition - When dwell time is completed a 4-second Trial for Ignition (TFI) period is initiated:

- a. The Delay-On (Low Fire Hold) Relay and the Gas Safety Valves are energized.
- b. During TFI the flame safeguard control will monitor the flame using flame rectification through the hot surface igniter.
- c. If the flame control senses the presence of flame before the end of the TFI period, the igniter will be de-energized and the flame control will continue to monitor the flame, through the igniter, until the operating thermostat ends the call for heat condition.

7. Loss of Flame Signal

- a. If the igniter fails to sense flame at any time, the igniter and gas valve will be de-energized and the flame control will reset and begin the call-for-heat sequence again. This will occur 3 times (one time if CSD-1) before the flame control will lockout.
- b. When the call for heat condition ends or flame failure occurs following the third TFI period (one time if CSD-1), a 30-second post-purge period will begin. This period of blower operation will exhaust any remaining combustion products from the system.

8. Delay-On Relay - Once the Delay-On (Low Fire Hold) Relay has timed out, it energizes the Modulation Release Relay (SPDT) to enable the analog signal from the TempTrac to the VFD to regulate the speed of the blower.

- a. The TempTrac will continue to monitor the stored water temperature in the tank.
- b. When the setpoint temperature is reached the call-for-heat signal to the flame safeguard control is discontinued.
- c. The flame safeguard control deenergizes the VFD blower system and the gas valve, thereby suspending burner operation.
- d. As heat is transferred to the building, the boiler loop temperature will fall below the set point. The TempTrac will sense this condition and begin the call-for-heat sequence again.

9. Flame Safeguard LED Diagnostic Indicator - If the Fenwal Flame Safeguard Control at any time during the operating sequence senses an improper operating state and locks out, the diagnostic red LED located on the control board will flash to indicate one of the following conditions exist:

LED INDICATION	FAULT MODE
On	Normal Operation
OFF	Internal Control Failure – check power
1 Flash	Airflow Fault
2 Flashes	Erroneous Flame Signal
3 Flashes	Ignition Lockout
4 Flashes	Hot Surface Igniter Fault
5 Flashes	Low Voltage (24 VAC)
6 Flashes	Valve Relay Problem

12 INITIAL STARTUP

12.1 Initial Startup Requirements

Installation should be complete prior to performing initial startup; and the startup must be complete prior to placing the boiler into service. Starting the boiler without proper piping, combustion air, venting or electrical systems can be dangerous and may void the product warranty. The following startup instructions should be followed precisely in order to achieve safe and efficient operation to assure trouble-free service life.

WARNING: Start-up must be performed by a qualified technician. The Start-up Forms is included with each product and must be furnished to the manufacture to register the warranty. Copies are available at www.riversidehydronics.com. Failure to comply can cause property damage, personal injury and exposure to hazardous materials or death.

WARNING: Turn off all power to the boiler when servicing or accessing the blower drive. The blower drive still has power when appliance switch is off. Failure to turn off all power to the boiler can cause personal injury, property damage or death.

12.1 Tools and Instrumentation Required

- Stack Temperature Gauge
- Stack Draft Gauge
- Electronic Combustion Analyzer
- Manometer for checking gas pressure (2 minimum)
- AC/DC Multi-meter (with 20,000 OHM/Volt rating)
- Amp Meter
- Normal Hand Tools

12.2 Resources

- Product Installation & Maintenance Manuals
- Start-up Report with instructions
- Local, State, & Federal Codes
- Toll Free 24-Hour Technical Support: 1-800-433-5654

12.3 On Site Considerations

- Electrical Supply in accordance with Nameplate Rating
- Uncontaminated Combustion Air
- Adequate Fuel Supply
- Treated Water Supply (Boilers)
- Consistent Draft

12.4 Startup Procedure

1. Carefully study the burner start-up information included in this manual.
2. Fill system tank with water. Some water appliances may be equipped with an optional air vent. If venting through the safety valve when filling the appliance, insure gags or fixtures are removed from the safety valve prior to start-up. Open the safety valve to allow air in the tank to escape.
3. Be sure all connections into the tank are tight, as leaks at tank fittings will damage the insulation.
4. **CAUTION:** Conduct the following gas train leakage test before start-up, at annual intervals and prior to investigating the cause of any reported occurrences of delayed ignition.
 - a. Using an appropriate bubble detection solution, thoroughly coat all gas train pipe connections. If any bubbles are detected, the leaking connection must be tightened, recoated, and rechecked to assure stoppage of the leak.
 - b. Attach a manometer to measure the gas pressure at the manual gas shutoff valve located just upstream of the gas train. Adjust gas train inlet pressure to the specified value (e.g. 14" W.C.), and tightly close the gas train manual shutoff valve closest to the burner.

- c. Reattach the manometer to the gas train manual shutoff valve at the burner and record the measured gas pressure in inches of water column (W.C.). Measure gas pressure again after 15 minutes. If gas pressure has increased 0.5" W.C. or more, the gas leak must be isolated to one or more of the operating gas valves. (For example, a solenoid actuated gas shutoff valve.) After any leaking valve is replaced, the reassembled gas train must be leak tested again before start-up is attempted.

5. Remove enclosure panel cover on the appliance to expose control circuit. A wiring diagram, included in this packet, will show the controls used in our circuitry.
6. Visually check that all components are intact and no damage has occurred during transit.
7. Check all connections within the control cabinet. A loose connection could cause intermittent shutdowns.
8. All burners will use a hot surface igniter (HSI) as the ignition source. They may use a single gas pressure regulator and valves, valve regulator combinations or multiple gas trains.
9. Connect a test meter to the control for reading the flame response signal.

NOTE: Some flame controls read the flame signal in micro amps and some in volts DC.

10. **CAUTION:** Be sure the tank is filled with water. Dry firing can destroy the appliance.
11. Check the inlet gas pressure before start-up, using a manometer or a 0 to 28" W.C. pressure gauge for inlet gas pressure. (This is the pressure measured before all components in the gas train.) This manometer must stay connected throughout the testing, as the inlet pressure must be monitored during the firing of the burner. Record static pressure; it must not exceed 14" W.C. Pressures above this could cause damage to the diaphragm in the gas valve or pressure regulator.
12. Connect a second manometer to the manifold test port at the shutoff valve closest to the burner.
13. **Turn-off main gas shutoff valve.**
14. **Disable or jumper out any BMS/BAS or OnTrac boiler control interface to allow independent setup and adjustment of each boiler.**
15. Turn unit on using the rocker switch on the front of the control enclosure assembly. When the burner fails to light, the flame control will lockout.

Start the burner in Low Fire (Burner combustion must be optimized at both Low and High Fire). To set the TempTrac control for manual modulation output:

- Push and hold the **EXT** key for more than 3 seconds. The **PS4** LED switches ON and the **PS4** parameter is displayed in the upper display, while the **PAS** label is shown in the lower display.
- Release the key, and insert the password: **3-2-1**. The value of the modulation parameter PS4 will be displayed in the lower display. **(nu)** stands for not used. Return to this condition for automatic operation.
- To adjust modulation manually, push the **SET** key, the value starts flashing. Then use **UP** or **DOWN** keys to modify it. **100 = High Fire; 0 = Low Fire.**
- To exit, press **SET + UP** or wait 30s without pressing any key.

NOTE: After a modification, it will be possible to enter the Modulation output setting without entering the password for 10min. After this time you will be asked for the password again.

16. **Turn-on main gas shutoff valve.**
17. If the operating control switches are closed, the burner blower should come on and pre-purge begins.
18. If nothing happens, check for a lockout condition and reset it by pushing the flame safeguard reset button. Some safety devices are wiring in the operating circuit and may not indicate alarm. If no indication of alarm exists, check gas pressure switches, electronic and float low water cutoffs and temperature limits.
19. When the blower motor starts the flame control will check for a positive air flow. If the air switch or blocked filter switch is not made the blower will stay on for a period of time then lockout. To adjust the air-proving switch, turn the adjustment screw counter-clockwise until the air proving light comes on, then turn the screw one turn counter-clockwise. The blocked filter switch should only be adjusted when the filter is new. This switch should be turned clockwise until switch makes and then two additional turns. If the gas valves open and close intermittently during normal operation, adjust pressure switches to increase the operational threshold until this condition ceases. This procedure should be followed with every burner.

20. After the pre-purge, the flame control energizes the HSI for the heat up period, approximately 30 seconds. At the end of that period the gas valve is opened for approximately 4 seconds. After the burner has lit and the primary safety control senses a flame, the burner will remain on until the call for heat is satisfied or operation is interrupted by a safety device.
21. If the burner fails to light, the flame control will lockout. When this happens press the reset button on the front of the control to recycle burner and check for improper combustion or weak flame signal as a possible cause.
22. Once the main burner flame is established the firing rate will be controlled by the TempTrac control. Refer to TempTrac manual 34-81.

Burner Combustion Adjustment

Burner combustion should only be adjusted using a combustion analyzer. Do not attempt to adjust burner by sound or sight. With the burner firing, insert the combustion analyzer probe in the flue vent approximately two feet from the appliance. **See Gas Train Illustration below for details.**

With the burner firing and adjusted to low fire, adjust the regulator screw clockwise to increase gas flow or counter clockwise to decrease flow. The desired CO₂ in the combustion products should be between 7.5 and 8.5%. Do not attempt to adjust combustion based on manifold pressure alone. Manifold pressure should only be used as a reference point.

- a. Once the desired combustion is achieved at low fire, raise the burner firing rate to high fire. Adjust the valve orifice clockwise to reduce the flow of gas and counter-clockwise to increase the flow of gas in order to maintain the desired CO₂ in the combustion products between 7.5 and 8.5%.
 - b. When high fire combustion has been reached and combustion is within the proper range, return to low fire to confirm settings again.
 - c. **CAUTION:** If at any point of the modulation range, carbon monoxide is in excess of 300ppm, contact **Riverside Hydronics** customer service for assistance.
23. **Enable or reconnect any BMS/BAS or OnTrac boiler control interface removed prior to the setup and adjustment of each boiler.**

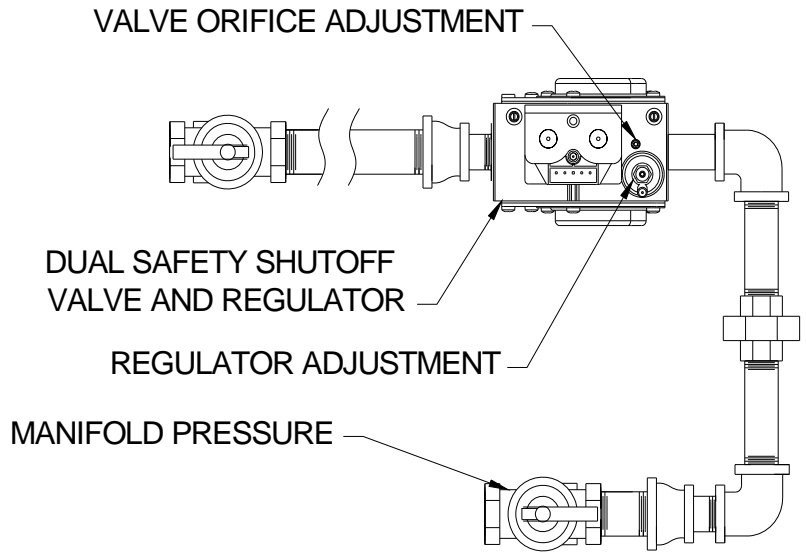

Gas Train Illustration for Centauri Models 250 through 500

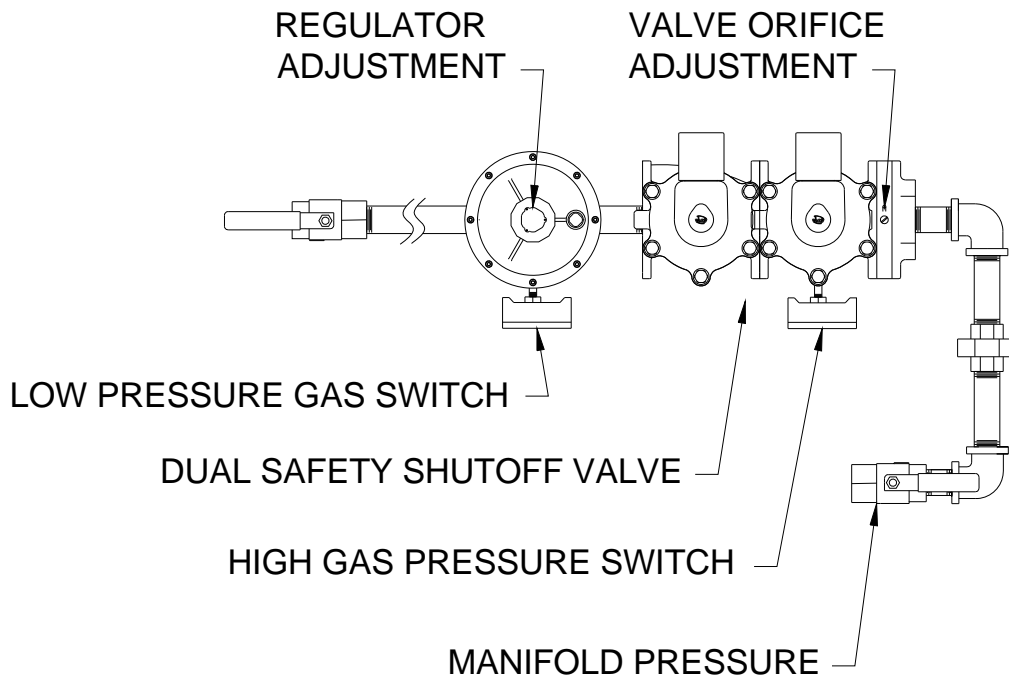

Gas Train Illustration for Centauri Models 650 through 2200

13 TROUBLESHOOTING GUIDE

Problem	Probable Cause	Corrective Action	
Starting or Pre-purge Failure	Power Supply	Check fuse and/or circuit breaker. Check voltage at 120/24V step-down transformer.	
	On-Off Switch	Check if On-Off switch is lighted	
	Temperature Control	Check that the operating temperature control is set higher than the temperature of the boiler.	
	Flame Safeguard Control	Check for bad ground or bad control. Replace if necessary.	
	Remote enable/disable open	Enable boiler or place jumper between terminals R1-R2.	
	Combustion Air blower		Check if fan connection terminals on flame control is closed
			Check for 24V at field access terminal C2. Remote interlock may be open.
			Fan VFD may be defective. Verify proper voltage.
	Air-proving Switch		Check switch contacts are closed.
			Check for 24V at the NOW side of air switch
Check for 24V at the common side of air switch			
Check for proper blower pressure setting – adjust if required. Air switch may be defective.			
Blocked Filter Switch		Check for 24V at the N.C. side of the blocked filter switch. Replace filter or switch as required.	
Flame Control Pressure Switch		Check for 24V at the pressure switch terminal.	
Loose Wire Connections		Check connections to all components	
Flame Failure	Power Supply	Check fuse and/or circuit breaker. Check voltage at 120/24V step-down transformer.	
	Flame Safeguard Control	Check for bad ground or bad control. Replace if necessary.	
	Hot Surface Igniter	Check resistance at room temperature and then the amperage draw during heat-up. Replace if the measured amperage is not within 3.5 to 5.0 amps or if measured resistance is not within 40-100 ohms (at room temperature). Also, check for overheating condition due to damaged refractory around igniter.	
	Air-proving Switch	Check if switch is bouncing. Adjust or replace.	
	Gas Pressure	Check for proper inlet static and dynamic gas pressure.	
	Combustion	Inadequate flame signal may result from improper combustion. Adjust to proper CO2 levels at low fire.	
	Grounding	Check for proper ground from flame control to burner housing.	
	Safety Limits	Check all safety limits for fault condition and correct as required.	

REPLACEMENT PARTS

14.1 Control Panel

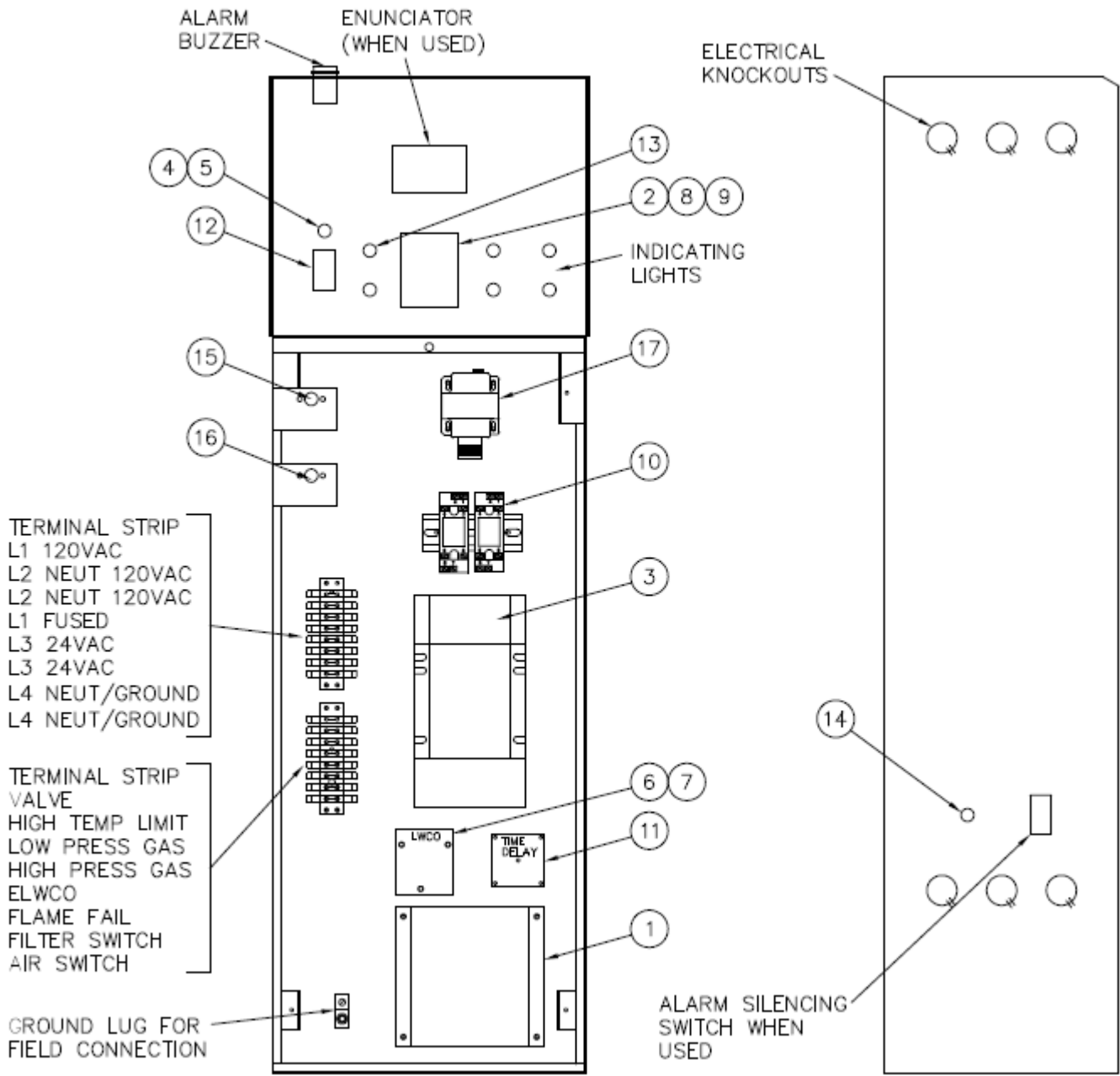

14.2 Control Panel Components
(Optional components may not be included)

Key No.	Part No.	Description	Qty.	U/M
1	101947	CONTROL, HOT SURFACE IGNITION FENWAL #35-679652-551 24V	1	EA
2	104796	CONTROL, TEMPERATURE TEMPTRAC #102920 REV A	1	EA
3	115747	DRIVE, VARIABLE FREQUENCY AC BALDOR #VS1-ST11P5-0T	1	EA
4	5613	FUSE HOLDER, PANEL TYPE #HTB-28I	1	EA
5	5742	FUSE, MDA 15 AMP BUSS 250V NO SUBSTITUTE	1	EA
6	113915	LWCO, PROTODESIGN #LW-3-C-1-A-03	1	EA
7	77412	PROBE, LWCO WARRICK #3B1B 3/8 MPT 316SS	1	EA
8	102163	PROBE, THERMOSTAT DIXELL #18NB-NTC-25FT NICKEL BRASS	1	EA
9	104195	PROBE, THERMOSTAT DIXELL #18NB-NTC-5FT NICKEL BRASS	1	EA
10	116458	RELAY, SPST 30A 24V OMRON #G7L-1A-TUB-J-CB-AC24 N.O.	1	EA
11	102835	RELAY, TIME DELAY ON SSAC #TDU3000A 24-120 VAC/DC 1 TO 102	1	EA
12	70565	SWITCH, CARLING #LTILA51-6SBLAM-NBL/125N/INDP BLACK W/AMBER	1	EA
13	70573	SWITCH, SPST N.C. MOMENTARY CONTACT SELECTA #SS229	2	EA
14	75908	SWITCH, SPST N.O. MOMENTARY CONTACT SELECTA #SS228	1	EA
15	111090	THERMOSTAT, JUMO #6000511773 240 DEG MANUAL RESET 3.3 CAP	1	EA
16	111091	THERMOSTAT, JUMO #6000511775 240 DEG AUTO RESET 3.3 CAP	1	EA
17	114863	TRANSFORMER, STEP DOWN RIB #TR100VA001 100 VA 120-24V 60HZ	1	EA

14.3 Burner Assembly

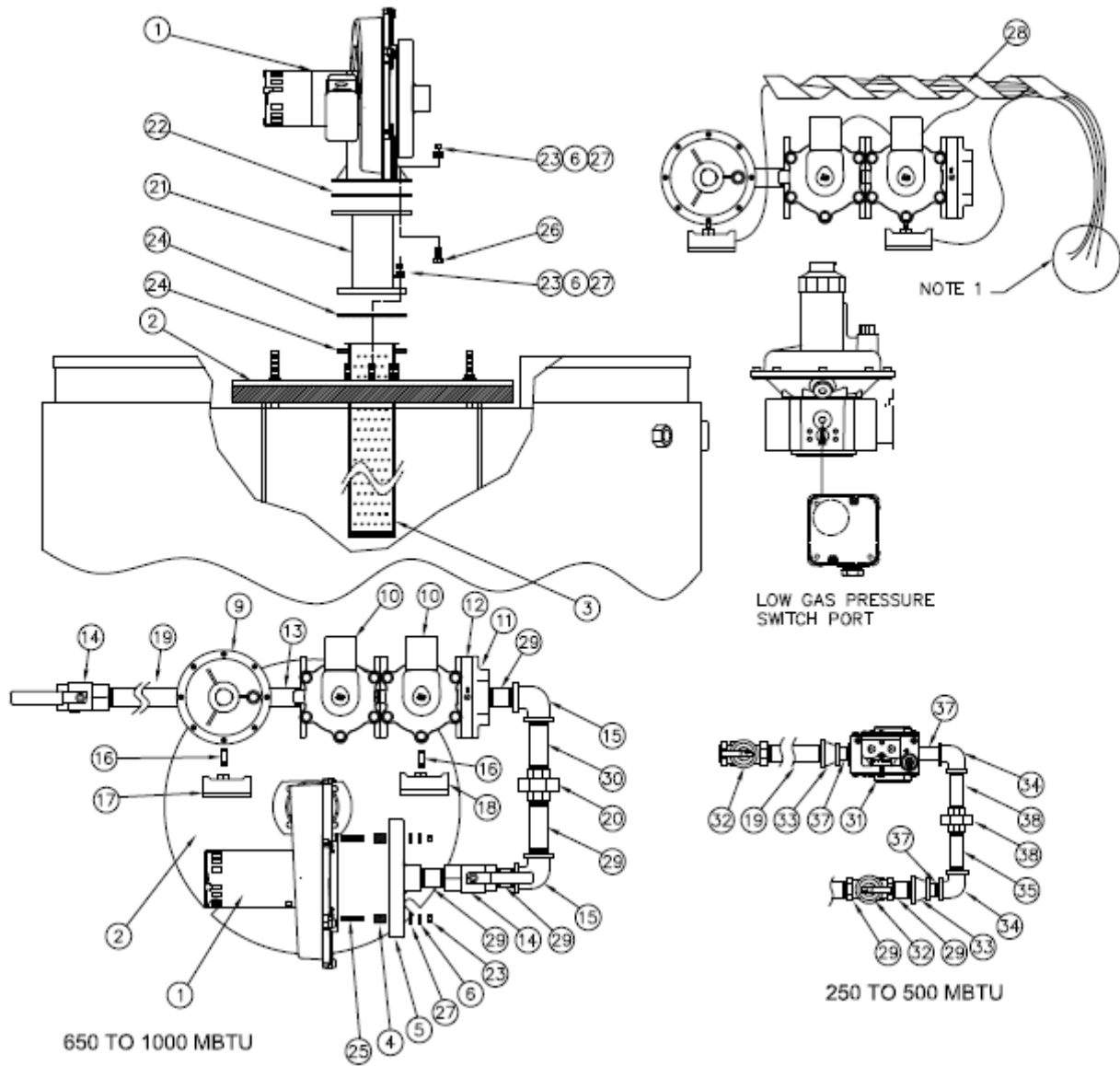

14.4 Burner Assembly Components
Optional components may not be included)

Key No.	Qty.	Part No.	Description
1	1	111876	BLOWER, FASCO #70430069
2	1	SEE BOM	ASSY, BULKHEAD REFRACTORY
3	1	SEE BOM	BURNER, METAL PUNCHED
4	6	114513	SPACER, NYLON 1/4 ID X 1/2 OD X 11/16 MCMASTER C
5	1	115248	ASSY, INTAKE GAS AIR 7 OD X 1 NPT
6	14	3494	WASHER, LOCK 1/4 PLT
7	6	111912	BOLT, 1/4 X 20 NC X 1 1/4 PLT HEX HEAD GR 5
8	16	64326	SCREW, M5 X 0.8 X 40 SOCKET HEAD CAP BLACK
9	1	79524	REGULATOR, 1 DUNGS #FRG710/6 ZERO GOVERNOR PROP
10	2	115769	VALVE,GAS 1 ASCO #JB821425O 24V 60AC
11	1	115785	FLANGE, ADAPTER 1 ASCO #296658-002 OUTLET
12	2	115786	SHUTTER,VALVE ASCO #HV426038001 1 TO 1 1/2 INCH
13	1	6011	NIPPLE,BLACK 1 X 2
14	2	52823	VALVE, SHUTOFF 1 GAS COMBU #55350 MODEL #840S.
15	2	6163	ELL, BLACK 90DEG 1
16	2	5973	NIPPLE, BLACK 1/4 X 2
17	1	101216	SWITCH, PRESSURE HGP-G ANTUNES #8101111202 2 - 20 W
18	1	101201	SWITCH, PRESSURE LGP-G ANTUNES #8103116202 1 - 20 W
19	1	SEE BOM	NIPPLE, BLACK 1
20	1	5929	UNION, BLACK 1
21	1	115255	ASSY, BURNER EXTENSION 2 X 5 FASCO MOD 43
22	1	113571	GASKET, BLOWER OUTLET 4.665 ROUND AMORIM #CR-55R 1
23	14	3475	NUT, HEX 1/4 X 20 NC STEEL ZINC PLT
24	2	102885	GASKET, FLANGE BLOWER 1/8 #232 CRANGLAS 2.500 ID
25	6	115745	STUD, THREADED 1/4 X 20 NC X 2 CRS GRAINGER #4REW2
26	6	55854	BOLT, 1/4 X 20 NC X 1 PLT HEX HEAD GR 5
27	14	15607	WASHER, FLAT 1/4 PLT
28	3	5624	WRAP, SPIRAL T25F
29	4	6012	NIPPLE, BLACK 1 X 3
30	1	6014	NIPPLE, BLACK 1 X 4
31	1	109843	VALVE, GAS 3/4 DUNGS #252605 TYPE GB-ND 057 24VAC.
32	2	5337	VALVE, SHUTOFF 1 KEY GAS #223-122111
33	2	46311	REDUCER, BELL BLACK 1 X 3/4
34	2	6160	ELL, BLACK 90DEG 3/4
35	2	5992	NIPPLE, BLACK 3/4 X 3
36	1	5928	UNION, BLACK 3/4
37	2	5991	NIPPLE, BLACK 3/4 X 2
38	1	5993	NIPPLE, BLACK 3/4 X 4

15 PERIODIC MAINTENANCE

Listed below are items that must be checked to ensure safe reliable operations. Maintenance must be performed by a qualified service or maintenance provider. To ensure proper maintenance, the following instructions should be posted near the appliance and maintained in legible condition. Verify proper operation after servicing.

WARNING: When servicing the controls, use exact, Factory authorized, replacement parts and label all wires prior to disconnection. Verify proper operation after servicing. Incorrect parts substitution and wiring errors can cause damage, improper operation, fire, carbon monoxide and other unexpected and unsafe conditions that could result in fire, injury or death.

1. Examine the appliance and venting system at least once a year. Check more often in first year to determine inspection interval.
 - a. Check all joints and pipe connections for tightness, corrosion or deterioration.
 - b. Check the electronic-ignition system for quick ignition and a proper flame signal.
 - c. Check all safety controls including thermostats for proper operation.
 - d. Check safety shut-off valves for operation and tightness.
 - e. Have the entire system, including, but not limited to, the burner, heat exchanger and venting system, periodically inspected by a qualified service agency.
2. Exposure to Dusty or Dirty Combustion Air: An appliance installed in a dust or dirt contaminated atmosphere will require replacement of the filter on a 3 to 6 month schedule or more often, based on severity of contamination. Contaminants can be drawn in with the combustion air. Inadequate combustion air or non-combustible particulate matter such as dust, dirt, dryer lint, concrete dust, dry wall dust or the like can block burner ports and cause unsafe operation and a non-warrantable failure. Do not remove filter without a suitable replacement. To inspect and clean the burner, a qualified serviceman or installer should use the procedures described in item 5 & 6 below.
3. Any sign of soot on the heat exchanger or in the flue indicates the need for a combustion inspection. Properly installed and adjusted units seldom need heat exchanger cleaning. If soot has formed, the most common causes are restricted combustion air or excessive gas. A blocked heat exchanger can cause unsafe operation and will reduce efficiency. To inspect and clean the heat exchanger, a qualified service agent or installer should use the procedures described in item 5 & 6 below.
4. All gaskets on disassembled components must be replaced on reassembly with exact, Factory Authorized, replacement parts only. Gasket kits are available from your Riverside Hydronics® Representative or by contacting Riverside Hydronics®, LLC.
5. Burner and/or Heat Exchanger Inspection and Cleaning Procedure:
 - a. Turn off main power to unit.
 - b. Turn off gas supply.
 - c. Write notes and/or take pictures during this process to aid in correct reassembly.
 - d. Remove the hot surface igniter, (HSI) from the burner. Be very careful not to bump the igniter element due to the fragility of the igniter.
 - e. Remove the nuts that secure the burner top plate to the burner flange and lift the burner top plate up until it is completely extracted from the burner.
 - f. Inspect top plate refractory for damage. The refractory should provide a tight seal against the top edge of the burner deck. The silicone foam gasket located on the top plate flange should also be checked for damage or excessive compression set.
 - g. With the burner top plate removed, inspect the deck surface of the burner for lent or other blockage carried in the fuel air stream. If blockage has accumulated, use brush to loosen debris and use a vacuum to remove from the burner cavities. Do not brush or scrub the metal fiber burner surface as this can cause permanent damage to the burner material.
 - h. Replace any damaged components and reassemble in reverse order. (4-5 ft/lbs).
 - i. Cycle unit and test to verify all safety and operating controls are properly functioning and the burner top plate flange is free of leaks.

6. The combustion air filter should be replaced every six months. If filter blockage becomes excessive the filter safety switch will not allow the burner to fire. To avoid nuisance shutdown in dirty environments, check and replace filter more frequently.
7. Inspect low water cutoffs and relief valves for proper operation at every six months, or more often if indicated by inspection.
8. Keep appliance area clear and free from combustible materials, gasoline and other flammable vapors and liquids.
9. Check frequently to be sure the flow of combustion and ventilation air is unobstructed to the appliance.
10. When electrical controls are serviced or replaced refer to ELECTRICAL COMPONENT LOCATIONS for identification and location of components.
11. All replacement parts are available through your Riverside Hydronics® Dealer. If you need assistance identifying or contacting your local dealer, you may contact Riverside Hydronics directly at the address and telephone number located on the first and last page of this manual.
12. If the appliance is to be shut down for an extended period of time, the primary gas valve and the water supply should be shut off. When the appliance is returned to service, a thorough inspection of all utilities and general appliance condition should be conducted.

16 RECOMMENDED MAINTENANCE SCHEDULE

1. Annual Maintenance

- a. Check all joints and pipe connections for tightness, corrosion or deterioration.
- b. Check the electronic-ignition system for quick ignition and a proper flame signal.
- c. Check all safety controls including thermostats for proper operation.
- d. Check safety shut-off valves for operation and tightness.
- e. Test flame failure detection system.
- f. Test high limit and operating temperature controls.
- g. Conduct a combustion test.
- h. Perform leakage test on pilot and main gas valves.
- i. Test air switch in functionality.

2. Semi-Annually

- a. Recalibrate all indicating and recording gauges.
- b. Check flame failure detection system components.
- c. Check firing rate control.
- d. Check piping and wiring of all interlocks and shutoff valves.
- e. Inspect burner components.
- f. Check igniter.
- g. Test high and low gas pressure interlocks.
- h. Check air filter and replace if required

3. Monthly Maintenance

- a. Test low-water cutoff device and alarm.
- b. Check flue, vent, stack, or outlet dampers.
- c. Check flame signal strength.
- d. Check flame failure detection system.
- e. Check firing rate control.
- f. Listen to and visually check the pilot and main fuel valves.

4. Daily Maintenance

- a. Check gauges, monitors, and indicators.
- b. Check instrument and equipment settings.

5. As Required

- a. Recondition or replace float low water cutoff device.
- b. Check drip leg and gas strainers.
- c. Test flame failure detection system.
- d. Test safety relief valves in accordance with ASME Boiler and Pressure Vessel Code Sections VI and VII.

NOTES:

MODEL NUMBER: _____

SERIAL NUMBER: _____

INSTALLATION DATE: _____